

GV-BL1500 1.3MP H.264 Super Low Lux WDR IR Bullet IP Camera



- 1.3 megapixel progressive scan super low lux CMOS
- Min. illumination at 0.01 lux
- Dual streams from H.264 and MJPEG
- Up to 30 fps at 1280 x 1024
- Intelligent IR
- IR distance up to 70 m (230 ft.)
- Vandal resistance (IK10 for metal casing)
- Ingress protection (IP67)
- Tolerant to extreme temperatures (-30°C ~ 50°C/-22°F ~ 122°F)
- Cable-concealed bracket preventing cable from being cut
- One alarm input and sensor output
- Built-in micro SD card slot (SD/SDHC) for local storage
- 2-way audio
- Wide Dynamic Range (WDR)
- 3D noise reduction
- Defog
- Motion detection
- Tampering alarm
- Privacy mask
- IP address filtering
- DC 12V / AC 24V / PoE
- Removable IR-cut filter for Day/Night function
- Supports iPhone, iPad, Android & 3GPP
- 31 languages on Web interface
- ONVIF (Profile S) conformant

* No Memory Card Slot & local storage function for Argentina.

Introduction

The Bullet Camera is specifically designed for outdoors. It adheres to the IP67 standard and has full protection against dust and jets of water. The camera is equipped with a super low lux image sensor, which allows the camera to provide a color live view in near darkness.

Active Tampering Alarm

Tampered



Focus Change



Camera Shift



Dimensions

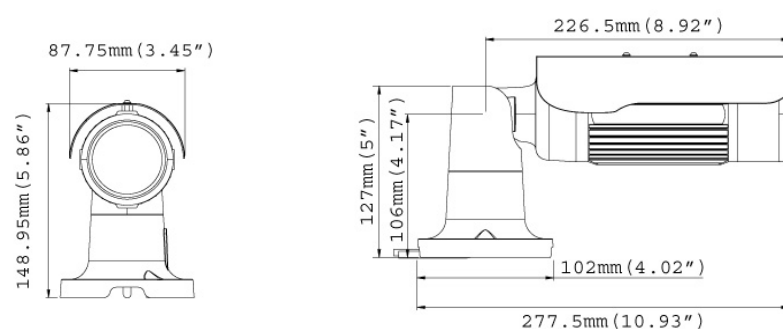

Specifications

Camera		
Image Sensor	1/3" progressive scan super low lux CMOS	
Picture Elements	1280 (H) x 1024 (V)	
Minimum Illumination	Color B/W	0.01 Lux
	IR ON	0 Lux
Shutter Speed	Automatic, Manual (1/5 ~ 1/8000 sec.)	
White Balance	Automatic, Manual (2800K ~ 8500K)	
Gain Control	Automatic	
S/N Ratio	55 dB	
WDR	Yes	
Lens		
Megapixel	Yes	
Focal Length	3 ~ 9 mm	
Day/Night	Yes (with removable IR-cut filter)	
Lens Type	Varifocal	
Maximum Aperture	F/1.2	
Mount	Ø 14 mm	
Image Format	1/2.7"	
Horizontal FOV	90° ~ 32°	
Operation	Focus	Manual (w/lock)
	Zoom	Manual (w/lock)
	Iris	DC Drive
Max. Torque (Focus/ Zoom Screws)	0.049 N.m	
IR LED Quantity	16 IR LEDs	
Max. IR Distance	70 m (230 ft.)	
Operation		
Video Compression	H.264, MJPEG	
Video Stream	Dual streams from H.264 and MJPEG	
Frame Rate	30 fps at 1280 x 1024 (SXGA) *The frame rate and the performance may vary depending on the number of connections and data bitrates (different scenes).	
Image Setting	Brightness, Contrast, Saturation, Sharpness, Gamma, White Balance, Flicker-less, Image Orientation, Backlight Compensation, Shutter Speed, D/N Sensitivity, WDR, Defog, Super Low Lux, Denoise, Metering	
Audio Compression	G.711, AAC (optional)	
Audio Support	Two-Way Audio	
Sensor Input	1 Input (Dry Contact)	
Alarm Output	1 Digital Output (200mA 5V DC)	
Video Resolution		
Main Stream	4 : 3	1280 x 960, 640 x 480, 320 x 240
	16 : 9	1280 x 720, 640 x 360, 448 x 252
	5 : 4	1280 x 1024, 640 x 512, 320 x 256
Sub Stream	4 : 3	640 x 480, 320 x 240
	16 : 9	640 x 360, 448 x 252
	5 : 4	640 x 512, 320 x 256
Network		
Interface	10/100 Ethernet	
Protocol	DHCP, DynDNS, FTP, HTTP, HTTPS, NTP, ONVIF (Profile S), PSIA, QoS (DSCP), RTSP, SNMP, SMTP, TCP, UDP, UPnP, 3GPP/ISMA	
Mechanical		
Temperature Detector	Yes	
Camera Angle Adjustment	Pan	0° ~ 360°
	Tilt	90° ~ 180°
	Rotate	0° ~ 360°
Connectors	Power	2-pin terminal block, PoE
	Ethernet	RJ-45
	Audio	1 In (RCA female for microphone) 1 Out (RCA female for speaker)
	Digital I/O	I/O Wires

Connectors	Local Storage	Micro SD card slot (SD/SDHC, SD version 2.0 only, Class 10) *SDXC and UHS-I card types are not supported.
General		
Environment Temperature	-30°C ~ 50 °C (-22 °F ~ 122 °F)	
Humidity	10% to 90% (no condensation)	
Power Source	12V DC / 24V AC / PoE	
Max. Power Consumption	7.68 W	
Dimensions	Camera Body	277.5 x 87.75 x 148.95 mm (10.9" x 3.45" x 5.86")
	Cable Length	1 m (3.28 ft.)
	Maximum Cable Diameter	ø 7.1 mm (0.28")
	Maximum Connector Diameter	ø 25.2 mm (0.99")
Weight	1.4 kg (3.08 lb)	
Ingress Protection	IP67	
Vandal Resistance	IK10 for metal casing	
Regulatory	CE, FCC, RCM, RoHS compliant	
Power over Ethernet		
PoE Standard	IEEE 802.3af Power over Ethernet / PD	
PoE Power Supply Type	End-Span	
PoE Power Output	Per Port 48V DC, 350mA. Max. 15.4 watts	
Web Interface		
Installation Management	Web-based configuration	
Maintenance	Firmware upgrade through Web Browser or Utility	
Access from Web Browser	Camera Live View, Video Recording, Change Video Quality, Bandwidth Control, Image Snapshot, Digital I/O control, Audio, Picture in Picture, Picture and Picture, Privacy Mask, Visual Automation, Tampering Alarm, Text Overlay, Digital PTZ	
Language	Arabic / Bulgarian / Czech / Danish / Dutch / English / Finnish / French / German / Greek / Hebrew / Hungarian / Indonesian / Italian / Japanese / Lithuanian / Norwegian / Persian / Polish / Portuguese / Romanian / Russian / Serbian / Simplified Chinese / Slovakian / Slovenian / Spanish / Swedish / Thai / Traditional Chinese / Turkish	
Application		
Network Storage	GV-NVR, GV-System, GV-Backup Center, GV-Recording Server	
Smart Device Access	GV-Eye for iOS and Android	
Live Viewing	IE, mobile phone	
CMS Server support	GV-Control Center, GV-Center V2, GV-VSM	

Note:







1. Specifications are subject to change without prior notice.
2. Mind the following when using an inserted memory card for recording:
 - Recorded data on the memory card can be damaged or lost if the data are accessed while the camera is under physical shock, power interruption, memory card detachment or when the memory card reaches the end of its lifespan. No guarantee is provided for such causes.
 - To avoid power outage, it is highly suggested to apply a battery backup (UPS).
 - For better performance, it is highly suggested to use Micro SD card of MLC NAND flash, Class 10.
 - Replace the memory card when its read/write speed is lower than 6 MB/s or when the memory card is frequently undetected by the camera.

Packing List

- | | |
|--|--------------------------------------|
| 1. Bullet Camera | 8. 2-Pin Terminal Block |
| 2. Lens (Megapixel and Built-In 16 IR LEDs) | 9. Power Adapter |
| 3. Self Tapping Screw x 3 | 10. GV-IPCAM H.264 Quick Start Guide |
| 4. Plastic Screw Anchor x 3 | 11. GV-IPCAM H.264 Software CD |
| 5. Torx Wrench x 2 | 12. GV-NVR Quick Start Guide |
| 6. Sun-Shield Cover Kit (1 Sun-Shield Cover, 2 Philips Head Screws, 2 Plastic Screw Spacers and 2 Hexagon Screws included) | 13. GV-NVR Software DVD |
| 7. Silica Gel Bag x 2 | |

Note: The power adapter can be excluded upon request.

Accessories

Model No.	Name		Details
GV-Mount300	Convex Corner Adapter Kit		Dimensions: 238.6 x 409.5 mm (9.4" x 16.1") Weight: 4.27 Kg (9.41 lb)
GV-Mount310	Concave Corner Adapter Kit		Dimensions: 238.6 x 409.5 mm (9.4" x 16.1") Weight: 4.27 Kg (9.41 lb)
GV-Mount400	Pole Mount Bracket Kit (\varnothing 4" ~ 6")		Dimensions Bracket: 241 x 161 mm (9.5" x 6.3") Weight: 1.70 Kg (3.75 lb) Steel Strap Diameter: \varnothing 4" ~ 6"
GV-Mount410	Pole Mount Bracket Kit (\varnothing 6" ~ 7.5")		Dimensions Bracket: 241 x 161 mm (9.5" x 6.3") Weight: 1.70 Kg (3.75 lb) Steel Strap Diameter: \varnothing 6" ~ 7.5"
GV-PA191 PoE Adapter	Power over Ethernet (PoE) Adapter		The GV-PA191 is a Power over Ethernet (PoE) adapter designed to provide power to the IP device through a single Ethernet cable.
GV-Relay V2	GV-Relay V2		The GV-Relay V2 is designed to expand the voltage load of GV IP devices. It provides 4 relay outputs, and each can be set as normally open (NO) or normally closed (NC) independently as per your requirement.
Power Adapter	Power adapters are available in 4 regions: U.S.A., Australia, U.K and Europe.		
GV-POE Switch	The GV-POE Switch is designed to provide power along with network connection for IP devices. The GV-POE Switch is available in various models with different numbers and types of ports.		